

T-Grid Linear Light

Installation Instructions

1. Unpack and check the luminaire and accessories.
Wear work gloves to keep the light clean, avoiding any oil or dirt transferred to it.

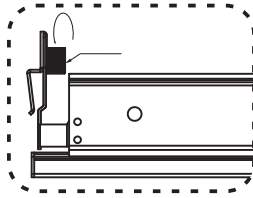

Figure1

2. Turn off the main power.

3. Unlock the two nuts at the ends of the linear light (Figure1).

4. Install the linear light to ceiling grid and tighten the two terminal nuts. (Figure2 and Figure3)

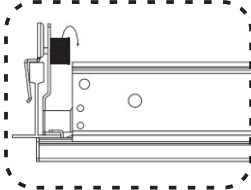

Figure2

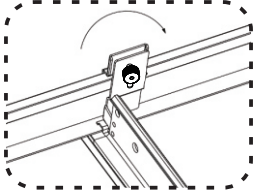

Figure3

5. Unlock the nuts from both end of Junction Box. (Figure4)

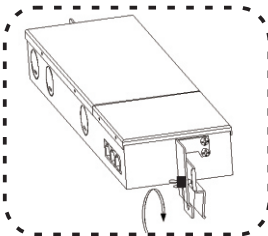

Figure4

6. Secure the junction box to the linear light and tighten the two terminal nuts. (Figure5 and Figure6)

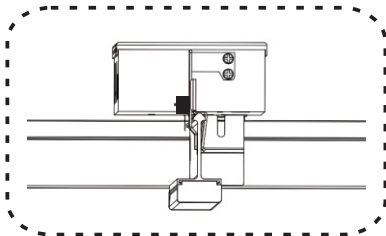

Figure5

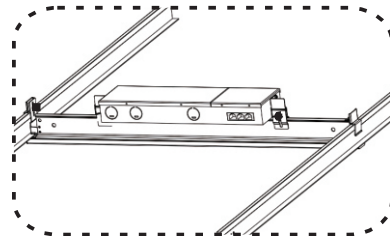

Figure6

7. Connect the connector(RJ45) from LED lighting unit to the output connector of Junction Box. (Figure7)
Please note one driver can only support max 3 units. (Figure8)

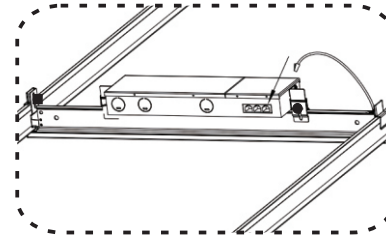

Figure7

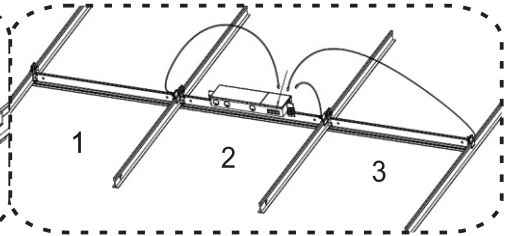

Figure8

8. Open the Junction Box, connect the L(Live), N(Neutral), G (Ground) wires by using the 4-pin connectors and connect the dimming wire with the orange connector cap.

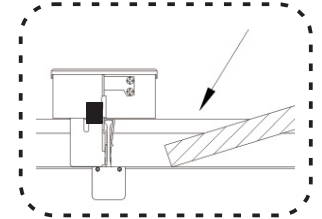
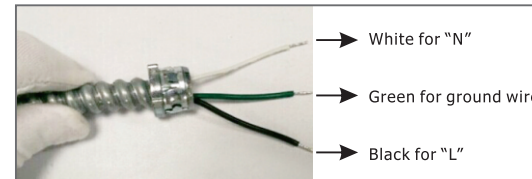

Figure9

9. Cover the plasterboard to finish installation and ensure there is no opening at ceiling. (Figure9 and Figure10)

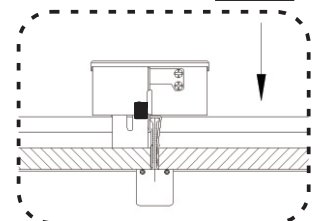
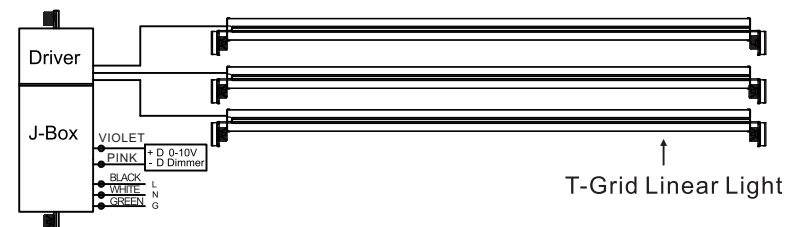

Figure10

Wiring Diagram



T-Grid Linear Light

Installation Instructions
("□" shape, "T" shape, "+" shape)

Note: for 15/16" & 9/16" standard flat versions only (not for wall wash and reflector type)

1. Remove the related T-grid from the drop ceiling according to your shape design.
For example, for "□" shape, remove the No.1, No.2, No.3, No.4, No.5 and No. 6 T-grid;
for "+" shape, remove the No.5, No.6, No.7 and No. 8 T-grid;
Pls note: The adjacent T-grid must be fixed by the pendant;
please do not replace the main-tee. (figure 1)

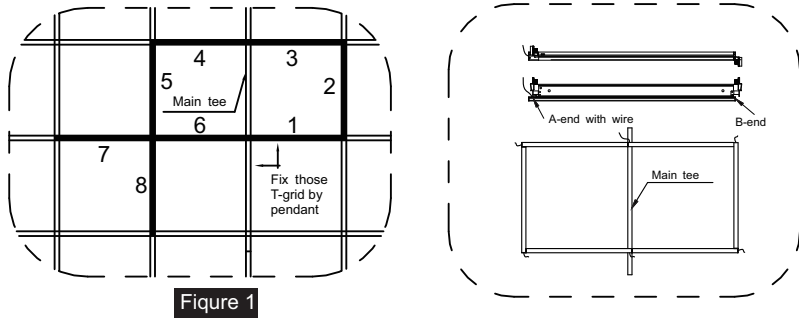

2. The "□" shape Installation Steps:

Step1, for the No. 1 light fixture, fix the A-end with wire of the No. 1 light fixture by pendant and the B-end on the "a" T-grid.
Step2, fix the No. 2 light fixture on the No. 1 light fixture with the A-end with wire, and the B-end on the "b" T-grid.
Step3, fix the No. 3 light fixture on the No. 2 light fixture with the A-end with wire, and the B-end on the "c" T-grid.
Step4, fix the No. 4 light fixture on the "c" T-grid with the A-end with wire, and the B-end on the "d" T-grid.
Step5, fix the No. 5 light fixture on the No. 4 light fixture with the A-end with wire, and the B-end on the "e" T-grid.
Step6, fix the No. 6 light fixture on the No. 5 light fixture with the A-end with wire, and the B-end on the "c" T-grid.
(figure 2, figure 3, figure 4, figure 5)

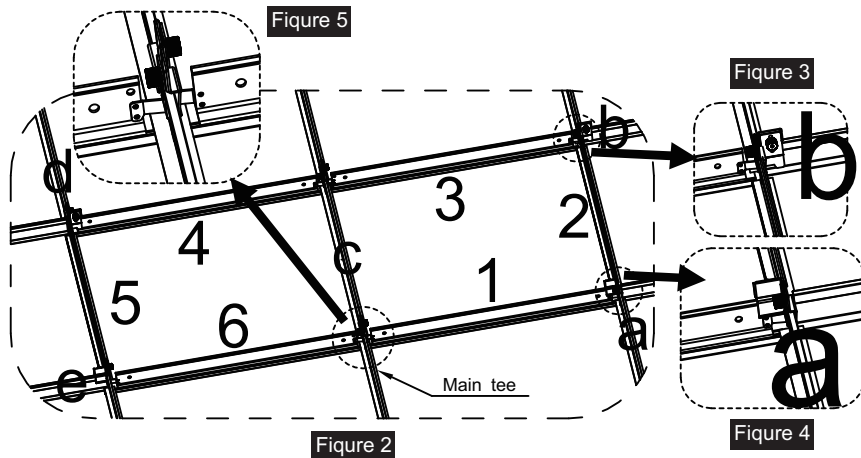

T-Grid Linear Light

Installation Instructions
("□" shape, "T" shape, "+" shape)

3. The "T" shape installation steps:

Firstly, install the No. 5 light fixture, fix the A-end with wire of the light fixture on the "d" T-grid and the B-end by pendant;
Secondly, fix the A-end with wire of the No. 6 light fixture on the No. 5 light fixture, and the B-end of the fixture on the "e" T-grid. using the same method fix the A-end with wire of the No. 7 light fixture on the "g" T-grid, and the B-end on the "f" T-grid.

The "+" shape installation steps:

follow up the "T" shape installation, and then replace the "f" T-grid with one light fixture. (Figure 6, Figure 7 and Figure 8)

